



TE055

# Álgebra de diagramas de blocos

Prof<sup>a</sup> Juliana L. M. Iamamura

# Álgebra de diagramas de blocos

- Associação de blocos em série

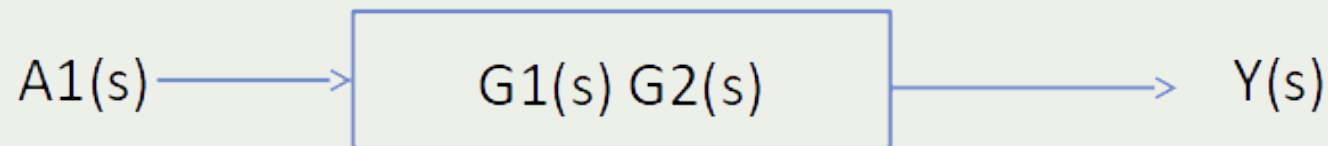
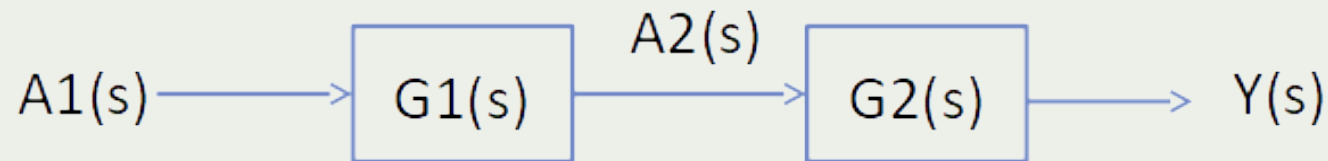

# Álgebra de diagramas de blocos

- Movimentação de um ponto de soma para trás de um bloco

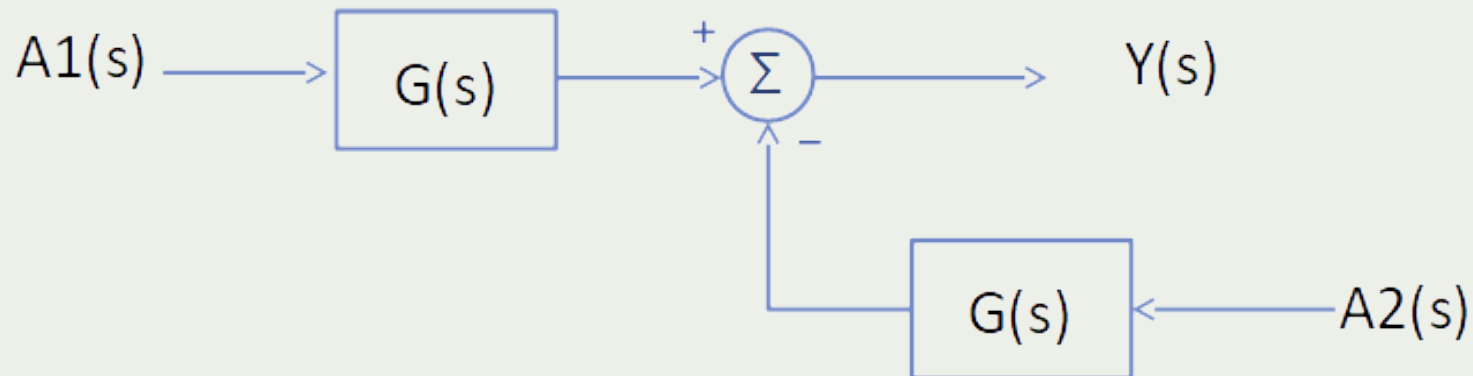
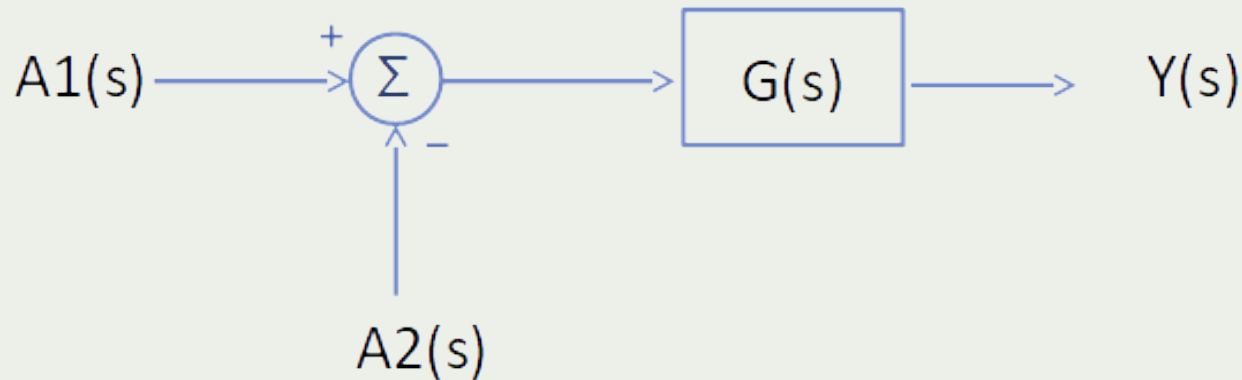

# Álgebra de diagramas de blocos

- Movimentação de um ponto de soma para a frente de um bloco

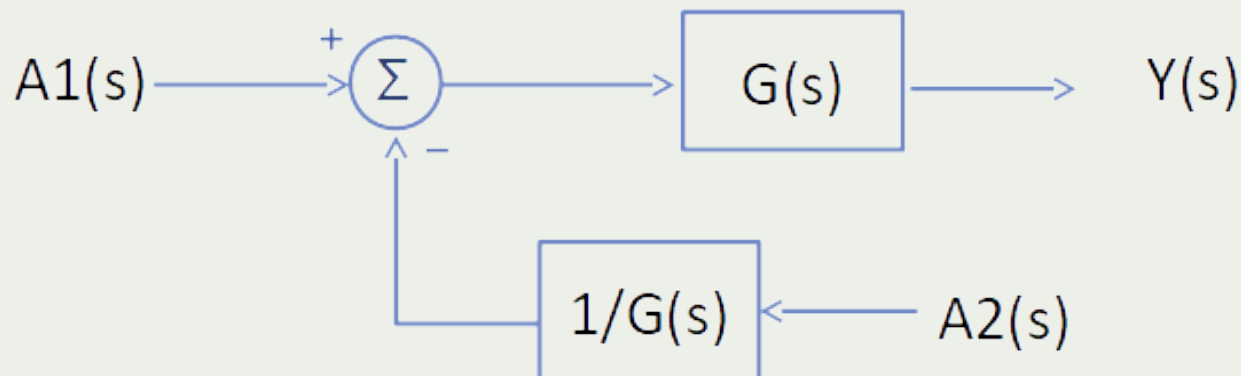
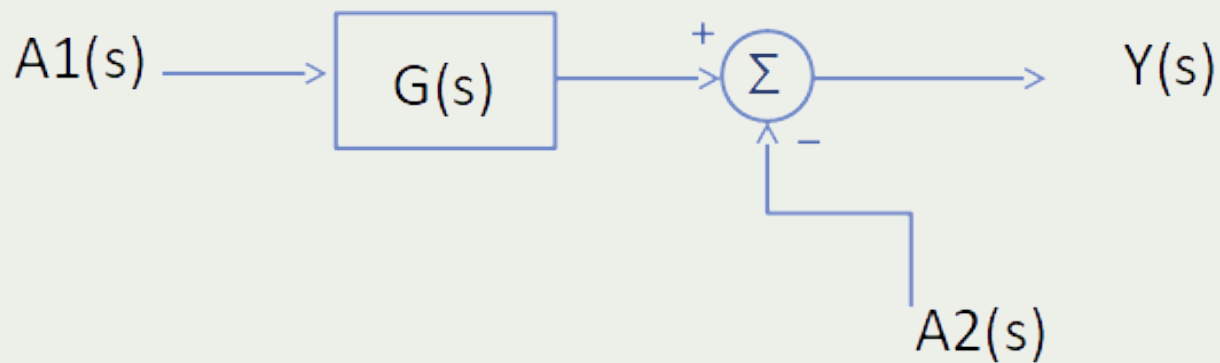

# Álgebra de diagramas de blocos

- Separação de pontos de soma

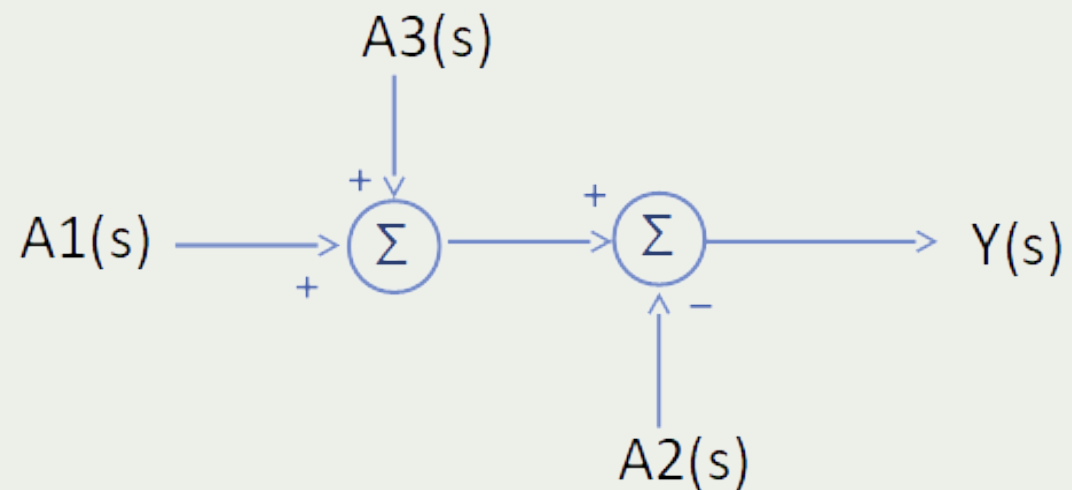
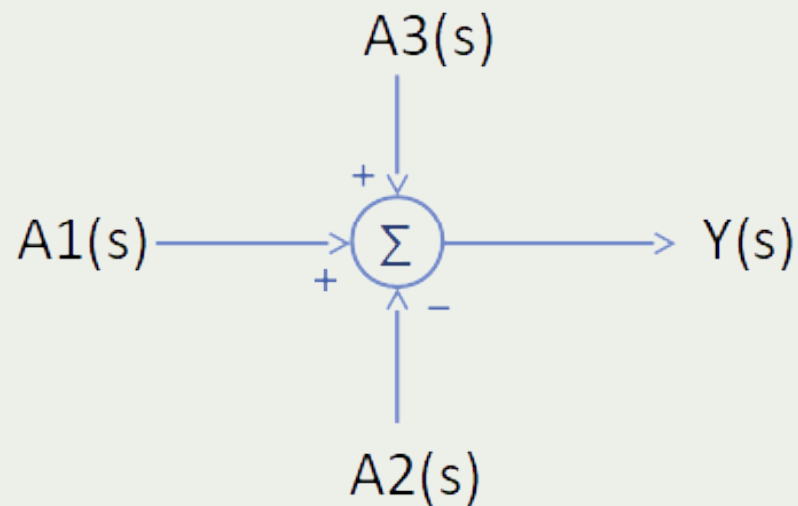

# Álgebra de diagramas de blocos

- Movimentação de um ponto de ramificação para frente de um bloco

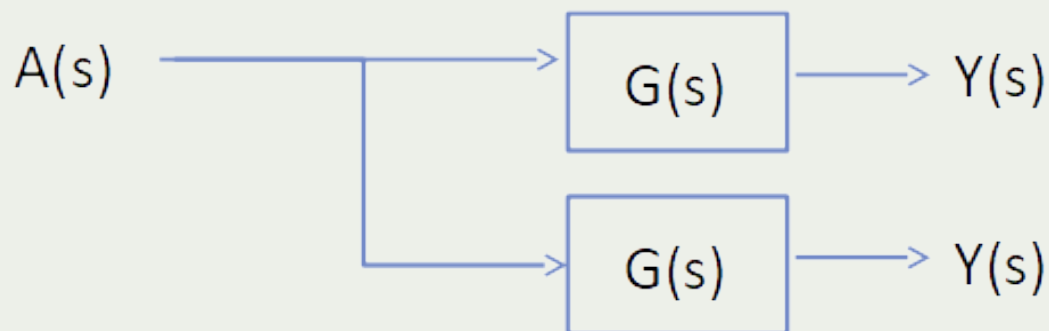
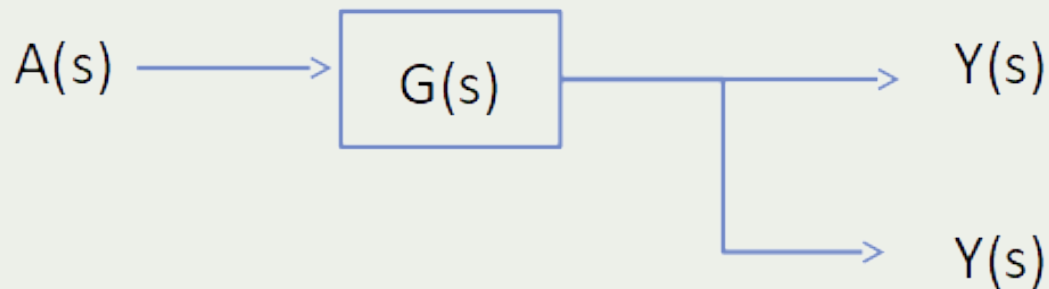

# Álgebra de diagramas de blocos

- Movimentação de um ponto de ramificação para trás de um bloco

